

TEKNA

MANUALE D'USO
USE MANUAL
MANUEL D'EMPLOI
GEBRAUCHSHANDBUCH
MANUAL DE USO



GENERAL CONTENTS

INTRODUCTION

PAG. 04

SAFETY RULES AND CAUTIONS

PAG. 05

DESCRIPTION OF THE MACHINE

PAG. 06

MACHINE OPERATIONS

1 st	STEP: TANK FILLING	PAGE 07
2 nd	STEP: LOWER DRUM FILLING	PAGE 07
3 rd	STEP: TURNING ON	PAGE 08
4 th	STEP: HOSE CONNECTION	PAGE 09
5 th	STEP: ACCESSORY STARTING	PAGE 09

ACCESSORIES EQUIPPED WITH THE MACHINE

1	HANDLE WITH HOSE	PAGE 10
2	MULTIFUNCTION BRUSH	PAGE 11
2A	FITTING FOR LIQUID SUCTION	PAGE 11
2B	FITTING FOR CARPETS	PAGE 11
2C	UNIVERSAL FITTING	PAGE 11
3	250 MM. WINDOW CLEANER	PAGE 12
4	150 MM. NOZZLE	PAGE 12
4A	WINDOW CLEANER FITTING	PAGE 12
4B	BRISTLE FITTING	PAGE 12
5	STEAM NOZZLE ADAPTER	PAGE 12
6	EXTENSIONS	PAGE 12
7	TANK FILLING BOTTLE	PAGE 12

ROUTINE MAINTENANCE

MOTOR SUPPORT	PAGE 13
FILTER AND SEPARATOR	PAGE 13
SPONGE FILTER	PAGE 14
AN OUTLINE OF THE MITE	PAGE 14

ACCESSORIES ON REQUEST

PAGE 15

TROUBLESHOOTING

PAGE 16

TECHNICAL SHEET

PAGE 17

SAFETY

PAGE 17

WARRANTY

PAGE 18

WARNING: Read the present manual before using the appliance.

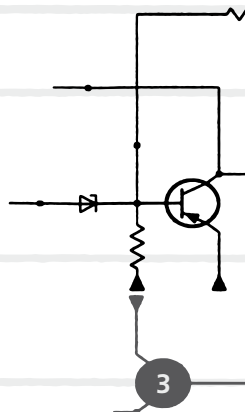

INTRODUCTION

WE THANK YOU FOR CHOOSING THIS PRODUCT MADE IN ITALY.

TEKNA IS THE RESULT OF A CAREFUL SEARCH CARRIED OUT BY PEOPLE KEEN ON CLEAN AND INNOVATION AND IT REPRESENTS THE NEWEST PRODUCT AMONG THE NEW-GENERATION MULTI-FUNCTION DEVICES.

TEKNA CARRIES OUT THE FUNCTIONS OF 5 DIFFERENT HOUSEHOLD APPLIANCES: IT SUCKS, WASHES, DRIES, SANITIZES AND IRONS. IT IS A SPECIAL, POWERFUL AND ECOLOGICAL MACHINE, IT DOESN'T NEED FILTERS OR BAGS TO BE REPLACED PERIODICALLY AND EXPLOITS THE NATURAL PROPERTIES OF WATER TO ENSURE MAXIMUM HYGIENE AND CLEANLINESS.

THANKS TO ITS SMALL OVERALL DIMENSION IT CAN BE HANDLED EASILY AND KEPT ANYWHERE. WE RECOMMEND READING CAREFULLY THIS MANUAL TO DISCOVER ALL ELEKTRA FEATURES AND POTENTIALITIES.

MOREOVER, WE RECOMMEND STRICTLY FOLLOWING THE ADVISES AND CAUTIONS FOR A CORRECT USE IN ORDER TO ENSURE VERY GOOD RESULTS AND SAFETY.

SAFETY RULES AND CAUTIONS

- Do not fill the boiler tank with detergent or disinfecting products.
- Do not turn the device upside down (the solenoid valve may get clogged).
- Do not suck flammable materials, explosives, concrete, gypsum or any other material which might create a dangerous mixture.
- If substances such as: wine, alcohol, ammonia, detergents or corrosive products are sucked, the lower drum might be damaged. We recommend emptying and rinsing it well.
- When suction is on level 5 (EXTRA POWER), use a proper ear protection.
- Make sure the surfaces and the parts to be cleaned can withstand steam (at the beginning we recommend using the steam on a small hidden area).
- Do not use steam on velvet, satin and leather.
- Before connecting your device, check that the voltage corresponds to the one written on the technical plate (220/230V).
- Do not use the appliance near people not wearing safety clothings.
WARNING: high power jets can be dangerous if used improperly. Never direct the jet towards people, animals, electrically powered appliances or towards the appliance itself.
- Never direct the jet towards yourself or other people for cleaning clothes and shoes.
- Use this device only for the functions it is conceived for.
- Disconnect the power supply before carrying out the maintenance operations.
- To disconnect the device, pull only the plug, ever the cable.
- Be careful the supply cable does not touch hot surfaces.
- Never use the device if the feeding cable or its other important parts are damaged for example, safety devices, high pressure flexible tubes, handle with controls.
- To avoid any risks of being electrocuted, do not disassemble it.
- Avoid connecting more powerful household appliances to the same electric circuit.
- If an extension cable is needed, make sure it is provided with earth; the plug and the socket must be watertight.
WARNING: unsuitable extension cables can be dangerous.
- Use an outlet provided with earth.
- Do not plunge the device into the water and do not use it in case of rain or snow.
- Do not sprinkle or wash the appliance.
- The appliance must be used neither by children nor by unskilled staff.
- Do not let the connected device be unguarded.
- Remember to disconnect the device before any cleaning or maintenance operation and at the end of every use.
- Let the device cool down before putting it back.
- Empty and rinse the lower drum after any use.
- For any repair, take the device to an authorised technical service.
- To ensure the safety of the appliance, use original spare parts supplied or approved by the manufacturer only. **WARNING:** hoses, accessories and connections are important for the safety of the appliance; use parts recommended by the manufacturer only.

Any intervention carried out by non-authorized repairers will forfeit the warranty.

The manufacturer is not to be held responsible for any failure due to incorrect use and maintenance.

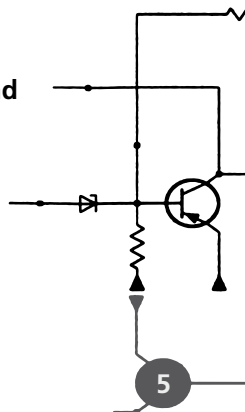

DESCRIPTION OF THE MACHINE

FIGURE "A"



Front part (fig. A)

- 01. Opening to insert the hoses
- 02. Control panel
- 03. Steam adjusting knob
- 04. Water tank plug
- 05. Upper cover
- 06. Handle
- 07. Lower drum
- 08. Closing hook
- 09. Wheels

FIGURE "B"



Rear part (fig. B)

- 01. Filter cover
- 02. Feeding cable
- 03. Cable winder

MACHINE OPERATION

1st STEP: TANK FILLING

- Remove the plug (fig.1)
- Fill the tank with water by using the suitable bottle supplied (fig.2) and by respecting the maximum capacity of the tank (any excessive water will be automatically discharged in the lower drum)
- Put the plug again.

NOTE: Use only the bottle supplied and avoid using any other object such as glasses and funnels to fill the tank. It may be overfilled. **DO NOT USE DISTILLED WATER.**



FIG.1



FIG.2

2nd STEP: LOWER DRUM FILLING

- Unhook the closing devices (fig.3)
- Lift the upper cover (fig.4)
- Fill the lower drum with about 2 litres of clean water (fig.5)
- Reposition the cover by paying attention to the drum level indicator. It must be in the front part (fig.6)

IMPORTANT: to avoid motor damages during the suction check that the liquid contained in the drum does not exceed the level indicated on the drum itself (MAX) (fig.6), otherwise we recommend emptying the drum.



FIG.3



FIG.4



FIG.5

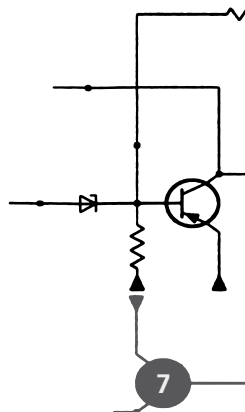

FIG.6



WARNING:

- Fill the lower drum only with water.
- Do not use fragrances-essential oils different from the ones approved by the Manufacturer. They may damage the drum.
- Empty and wash the drum after each use.
- To clean the drum, use natural soap and rinse with abundant water.



3rd STEP: TURNING ON

- Connect the supply cable to a 230V plug provided with earth. Three red lights appear on display "e".
- For the vacuum cleaner function: press push button "B" and adjust the power by means of keys +/-.
- For the steam function: press push button "A", after about three minutes pilot light "d" lights up and the device reaches the optimum working temperature and pressure. The steam must be adjusted by means of the knob (fig.7) according to the surface to be treated.
- The temperature remains displayed on the display. Once the other functions are selected, the display shows them about 5 seconds.
- For the iron / carpet cleaner function: press push button "C", the corresponding pilot light lights up and the writing "ACC" appears on the display.

NOTE: when pilot light "f" signalling that the water is finished is on, the flashing writing "H2O" appears on the display and in the meantime the steam delivery is stopped. In this case fill the tank with water. (step 1).

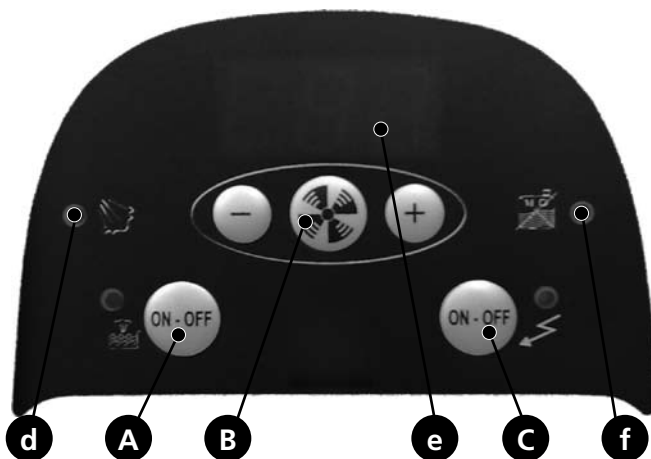

LIST OF THE PANEL FUNCTIONS

- A. Push button to turn the boiler on
- B. Push button to start and adjust the motor (+/-)
- C. Push button to start the iron / carpet cleaner
- d. Pilot light signalling the steam is ready
- e. Display
- f. Pilot light signalling the water is finished

4th STEP: HOSE CONNECTION

- To connect the hose, move upwards the door covering the plug (fig.8), insert the plug and close the door by making sure the pawl is into its proper seat (fig.8a).

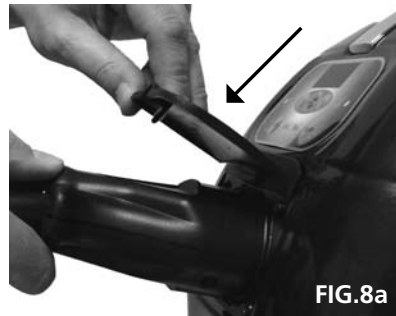
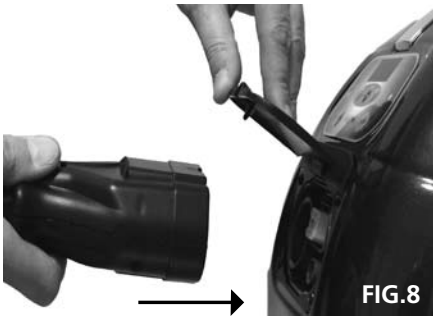

5th STEP: ACCESSORY STARTING

- All the accessories carry out the double function of suction and steam. They fit in directly on the handle or on the extensions.
- Move the ring nut to open position (fig.9).
- Fit in the extension hose or the accessory (fig.10).
- Move the ring nut to close position (fig.11).
- Move the slider to safe position (only for the extensions fig.12).
- Press the push button located on the ergonomic handle to turn the suction on and off (fig.13).
- Keep pressed the push button located under the handle to deliver the steam and release it to interrupt the delivery (fig.14).

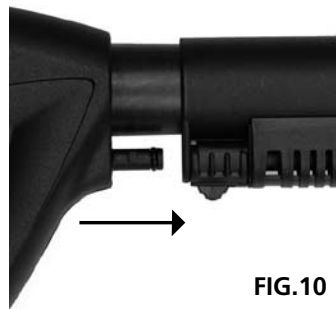

FIG.10

FIG.11



FIG.12



FIG.13

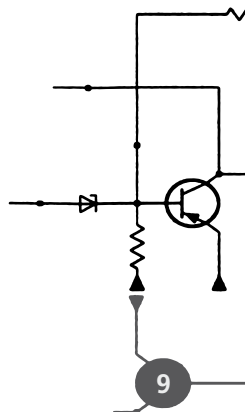

FIG.14

NOTE: some water may create in the hose. It may come out during the first seconds of use.



WARNING: do not use steam on electric fixtures which are on or energized!



ACCESSORIES SUPPLIED WITH THE MACHINE

1. Handle with hose
2. Multifunction brush
- 2A. Fitting for liquid suction
- 2B. Fitting for carpets
- 2C. Universal fitting
3. 250mm window cleaner
4. 150mm nozzle
- 4A. Window cleaner fitting
- 4B. Fitting with bristle
5. Steam lance adapter
- 5A. Bristle brush with 30mm diameter
- 5B. 80mm nozzle
- 5C. Lance
6. Extensions
7. Tank filling bottle





1. HANDLE WITH HOSE

- A. Plug
- B. Hose
- C. Handle
- d. Steam push button
- e. Suction push button

MAINTENANCE OF THE HOSE

After every use we recommend rinsing the hose by sucking one/two litres of water from a basin to prevent the dirt from settling on the internal walls. Then, hook it, so that it can get dry.

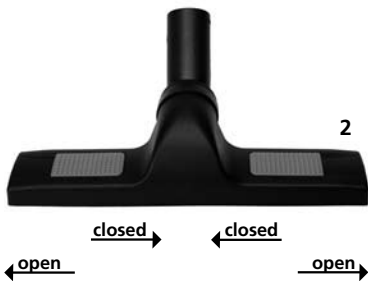

2. MULTIFUNCTION BRUSH

It is equipped by an articulation which allows it to turn 360°. This brush can clean areas difficult to be reached (under the furniture and the beds, on high cupboards, etc.) and various kind of floor, carpets, etc.

To use the desired fitting on the brush, just insert it and by keeping it pressed, move the orange sliders inwards (fig. 2). To remove the fitting, move the sliders outwards.



2A. FITTING FOR LIQUID SUCTION

It is fitted to clean floors, plastic coatings, marble, etc.. Steam the surface to be cleaned and then suck; the result is a perfectly clean and dry surface.



2B. FITTING FOR CARPETS

The rounded shape allows sliding and cleaning carpets and fitted carpets more easily.



2C. UNIVERSAL FITTING

It can be used as vacuum cleaner on floors, tiles, plastic coatings.

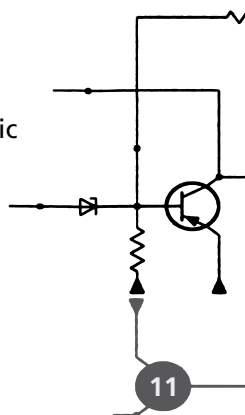



3. 250MM WINDOW CLEANER

The window cleaner is particularly suitable for the cleaning of windows and mirrors. For the use refer to point 4A.

NOTE: in winter the windows must be previously warmed by using the accessory at a distance of 10/15 cm. before starting cleaning



4. 150MM NOZZLE

It is a brush on which the following fittings can be assembled:



4A. WINDOW CLEANER FITTING

Ideal to clean "English" windows. For a correct use we recommend warming the accessory by keeping the steam push button pressed for some seconds and steaming in the air. Then proceed with the cleaning.

It is possible to steam and suck at the same time or separately. We recommend using the window cleaner from the top to the bottom by keeping it well pushed on the window.



4B. BRISTLE FITTING

It can be used to clean sofas, armchairs, seats, etc.

For a correct use steam and suck by keeping pressed the brush against the surface so that the dirt can be easily removed.

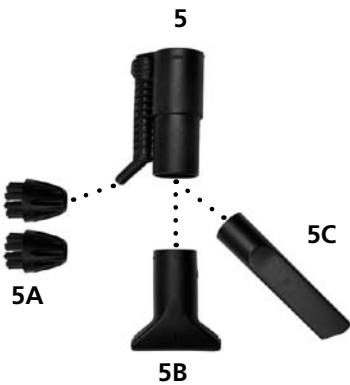

5. ADAPTER FOR THE STEAM LANCE

5A. Bristle brush diameter 30mm

5B. 80mm nozzle

5C. Lance

Particularly recommended to clean shower boxes, grills, fly screens and the spaces between the tiles etc. Ideal also for the defrosting of freezers or refrigerators.

IMPORTANT: adjust the pressure of the steam according to the type of surface. Pay attention to the more delicate surfaces.



6. EXTENSIONS

Essential to clean floors, washable walls or high windows. They can be used combined with any other accessory.



7. BOTTLE TO FILL THE TANK

ROUTINE MAINTENANCE

MOTOR SUPPORT (D)

It is located under the upper cover. For the cleaning at first we recommend disconnecting the device. Use only a wet cloth. Do not use direct water jets (i.e.: shower, tap, etc.).

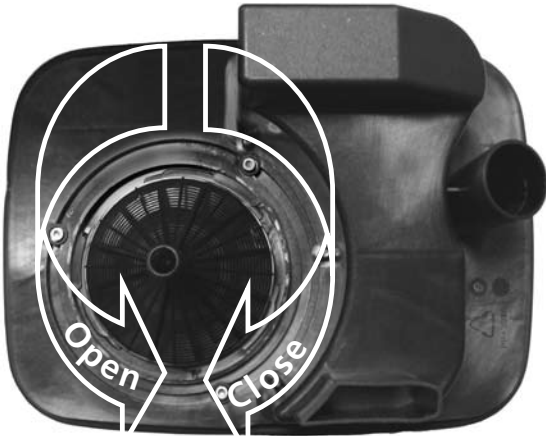

DO NOT INCLINE THE MACHINE MORE THAN 45°.

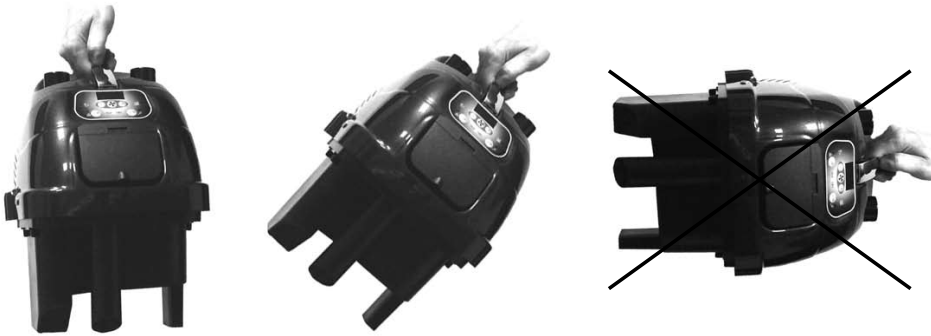

FILTER AND SEPARATOR

The plastic filter (C) is fixed on the motor support (D). To remove it, just turn it anticlockwise. Wash it with water. Once the filter has been removed you can see the "molecular separator" (A).

This separator must be periodically washed with water. To remove it loosen the knurled screw (B) and take it out from its seat. Pay attention when inserting it again since it is provided with a fastening seat. Turn the knurled screw clockwise by using your hands and without fastening too much. Never use the machine when the plastic filter is not inserted.

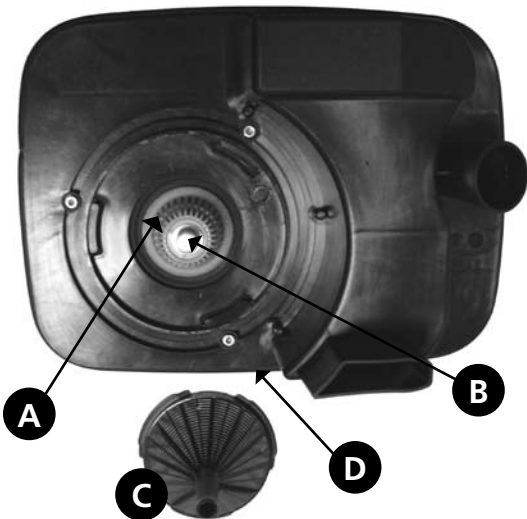

- A. Molecular separator
- B. Knurled screw
- C. Filter
- D. Motor support

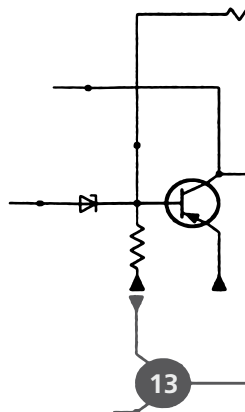

SPONGE FILTER

The filter cover (A) is located in the rear part of the machine and can be removed by unscrewing the stop nut (F) (fig.17-18).

Once the filter cover has been removed, you can reach the silencer filter (C) which is located in the motor air outlet (D). We recommend cleaning it periodically by washing it with water.

- A. Filter cover
- B. Coupling pin
- C. Silencer filter
- D. Air outlet
- E. Washer
- F. Stop nut

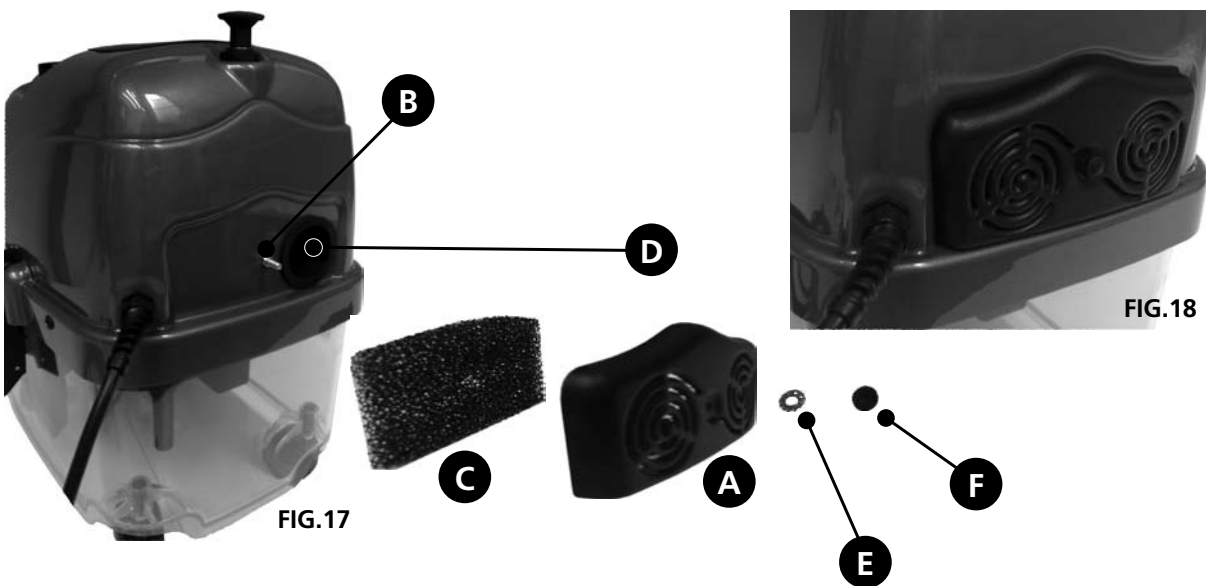

AN OUTLINE OF THE MITE

The mite lives and deposits its faeces in upholsteries, cupboards, fitted carpets, pillows, mattresses and in rooms which have been closed for a long time. The mite may cause the children and the elderly allergies, bronchial asthma, conjunctivitis, dermatitis, rhinitis. We recommend airing the rooms much and constantly to reduce the mites presence (at least 15 minutes every two hours!).

The traditional vacuum cleaner is not enough: the common paper bags let filter a part of the dust which comes back in the air, together with mites and moulds thus troubling in particular asthmatic people.

Besides using the steam cleaning power, the product can solve filtering problems, thanks to its revolutionary water filter.



OPTIONAL:

1



1. IRON

- Open the door located in the front part of the machine
- Insert the iron pin into the plug of the device
- Close the door
- Adjust the thermostat on the desired position according to the fabrics
- Turn on the push button (C) of the control panel
- Wait for a few seconds, till the iron is warm
- By pressing the push button on the handle of the iron the steam is delivered
- To adjust the pressure of the steam use knob (3)
- To remove the pin from the unit, at first open the door and then pull out the plug

2



2. IRONING BOARD

The table folding ironing board is practical and it can be hung or put away in horizontal or vertical position. The surface is in radiant aluminium and has a weight lower than 10Kg. It sucks and heats up the whole surface thus ensuring a good ironing and drying of the clothes.

3



3. ELECTRIC CARPET CLEANER

Very good to suck thoroughly carpets, fitted carpets, mattresses etc..

4



4. ACQUA CLEAN

ANTIBACTERIAL EFFICACY TESTED AT 99,999%
Thanks to natural active principles with an effective "antiseptic and sanitizing" action, it prevents bacteria from forming removing bad smell caused by water impurities. When it is diffused in the air during the machine use, it "cleans" the air effectively removing bad smell in the house as smoke, kitchen smell, dust, etc. Put some drops (at least 1 cap) together with water in the lower drum of the machine.

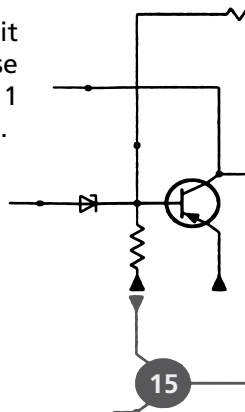

TROUBLESHOOTING

Sometimes problems arise from causes which can be easily removed by carrying out simple checks.

PROBLEM	CAUSE	SOLUTION
Insufficient suction	<ul style="list-style-type: none"> · The plastic filter of the separator is dirty or clogged · Power is too low · The hose is clogged · The lower drum is full 	<ul style="list-style-type: none"> · Clean the filter · Increase power · Disconnect the hose and remove dirt · Empty the drum and restore the minimum level with clean water
The motor is noisy	The lower drum is full	Empty the drum and restore the minimum level with clean water
When the boiler is ready, steam does not come out	Adjustment is low	Increase the output power
When the boiler is ready, steam does not come out and the display shows the message H2o	Water has finished in the tank	Fill the tank by means of the proper bottle
The extension hoses or the accessories loosen easily	The fastening ring nut is not in its correct position	Fix the fastening ring nut in its proper position
The extension hoses or the accessories are not coupled easily	<ul style="list-style-type: none"> · Gaskets are not lubricated · Gaskets are damaged · The fastening ring nut is not in its correct position 	<ul style="list-style-type: none"> · Lubricate gaskets by using teflon grease or hand cream · Replace gaskets with those supplied · Put the fastening ring nut in open position
Light water/steam escape from the couplings (of: accessories, extension hoses, hose)	Gaskets are damaged	Replace gaskets with those supplied. Lubricate gaskets by using teflon grease or hand cream
The controls on the hose handle do not respond	The plug unit of the hose has not been connected properly	Connect the plug unit until the door is properly closed
The hose loosens from the machine	The plug unit of the hose has not been connected properly	Connect the plug unit until the door is properly closed
The iron does not get hot	<ul style="list-style-type: none"> · The iron function has not been selected from the panel · The iron temperature is too low · The plug unit of the iron has not been connected properly 	<ul style="list-style-type: none"> · Enable the function (the display will show the ACC message) · Increase the iron temperature · Connect the plug unit until the door is properly closed
The iron drips out water instead of steam	<ul style="list-style-type: none"> · The iron temperature is too low · The user has not waited for the correct heating time of the iron 	<ul style="list-style-type: none"> · Increase the iron temperature · Wait for some minutes

If, after carrying out these checks, the appliance does not work, please contact the Technical Assistance Service.

TECHNICAL SHEET

- Dimension (cm.) 37 x 30 x 40h
- Voltage 220-230 Volt 50-60 Hz
- Pressure 4 - 4,5 Pa
- Resistance 1,8 - 2 Kw
- Turbine engine 1000 - 1200 Watt
- Operation temperature: 5-30°C
- Stainless steel boiler
- Electric supply cable 6 m
- Steam ready time 3 minutes
- Basin capacity 5,5 l. max
- Steam outlet 43 g/mn
- Unlimited boiler endurance

SAFETY

- Device stopping the circuit at tank and boiler level
- Thermostat
- Thermofuse
- Pressure switch
- Safety valve 6 bar
- Low voltage control
- Appliance complying with the low tension directive 2006/95/CE
- Product norms EN 60335-1, EN 60335-2-2, EN 60335-2-79
- Electric, electronic, pressure temperature: EEC norms
- Protection degree IP24



WARNING:
DANGER OF BURNS.

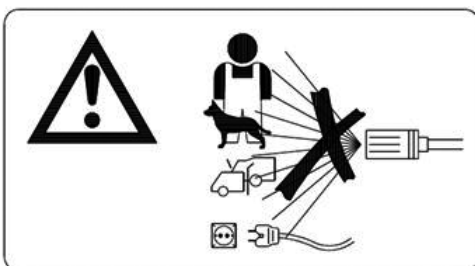

WARRANTY AND TECHNICAL SERVICE

For any malfunction, please contact your dealer or the Technical Service.
Never repair your device on your own. The regulations at the basis of its manufacture might break and consequently the warranty might forfeit.
The warranty forfeits also when any intervention is carried out by non-authorized staff.

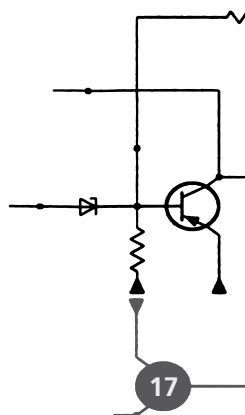

WARRANTY COUPON

DATE OF SALE:

MODEL:

SERIAL NUMBER:

DEALER STAMP:



CONDITIONS

The device sold is guaranteed according to the Law for possible manufacture failures. During this period, the faulty components are replaced free, if the failure is not caused by collisions, falls, fires, short circuits or by an improper use. The non-working device or the faulty parts are to be sent carriage free to our Company or to the authorised Technical Service. We send the repaired components back carriage paid to the purchaser address.

INFORMATION FOR THE USERS ON THE DISPOSAL OF OUTDATED ELECTRIC AND ELECTRONIC DEVICES (FOR PRIVATE FAMILY UNIT)

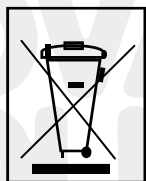

This symbol on the products and/or on the documents means that the electric and electronic products used are not to be disposed of with generic household waste. For a correct treatment, reutilization and recycling take these products to the collecting points, where they are accepted free. Alternatively, in some Countries the products could be given back to the local dealer when purchasing another equivalent product. A correct disposal of this product will allow saving precious resources and avoid possible negative effects on the human health and on the environment. For further details, contact the local authority or the nearest collecting point. In case of wrong disposal, penalties may be applied according to the Local Law. For the Companies of the European Union: if you wish to dispose of electric and electronic devices, contact the dealer or the supplier for further details. Information about disposal in Countries not belonging to the European Union. This symbol is valid only in the European Union. If the device should be disposed of, contact the local authority or the dealer and ask for information about a correct disposal.

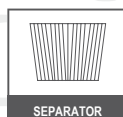

Made in Italy